



COM100D/COM100E
Smart Communication Box
User Manual

Contents

1	About This Manual	1
1.1	Validity	1
1.2	Type Description.....	1
1.3	Intended Use	1
1.4	Target Group	1
1.5	How to Use This Manual	2
1.6	Symbol Explanation.....	2
2	Safety Instruction	4
3	Product Introduction.....	6
3.1	Function Description.....	6
3.1.1	Brief Introduction	6
3.1.2	Networking Application	6
3.2	Appearance.....	8
3.3	Dimensions	8
4	Installation Flow	9
5	Mechanical Installation	10
5.1	Unpacking and Inspection	10
5.2	Location Requirements	11
5.3	Installation Tools.....	11
5.4	Installation Method	12
5.4.1	Wall-Mounting	12
5.4.2	Pole-Mounting (Optional).....	14
5.5	Antenna Connection (Optional)	15
6	Electrical Connection	17
6.1	Waterproof Terminal Description	17
6.2	Internal Structure.....	18
6.3	Preparation Before Cable Connection.....	18
6.4	Grounding	19
6.5	RS485 Port.....	19
6.5.1	Connect to the Device with RS485 Port	19

6.5.2	Connect to the Device with RJ45 Port	21
6.6	Ethernet Port	22
6.7	External AC Power Supply Cable	22
6.8	External DC Power Supply Cable	23
6.9	Inspection after Cable Connection	24
7	Commissioning	25
7.1	Check before Commissioning	25
7.2	Commissioning Steps	25
8	Grid Dispatching Function	27
8.1	Function Description	27
8.2	Interface Description	28
8.2.1	Digital Control Interface	28
8.2.2	Analog Control Interface	30
8.2.3	DRM Control Interface	30
9	WEB Interface	32
9.1	Running Requirements	32
9.2	Configure PC Network Parameters	32
9.3	Login Steps	33
9.4	Interface Introduction	33
10	Appendix	34
10.1	Technical Parameters	34
10.2	Quality Guarantee	35
10.3	Contact	36

1 About This Manual

1.1 Validity

This manual is valid for the smart communication box researched and manufactured by Sungrow Power Supply Co., Ltd.

- COM100D
- COM100E

The foregoing smart communication boxes are referred to as the "COM100" for short unless otherwise specified.

1.2 Type Description

Type	Configuration	Communication manner
COM100D	Includes Logger1000A, switch-mode power supply, surge protection device, micro circuit breaker, and lighting device inside	Support of 4G and WiFi communication
COM100E	Includes Logger1000B, switch-mode power supply, surge protection device, micro circuit breaker, and lighting device inside	Support of WiFi communication

1.3 Intended Use

This manual is intended to provide the reader with detailed information on the COM 100 and describe how to install and operate the device.

1.4 Target Group

This manual is intended for technically qualified persons who need to install, operate, and maintain the COM100 and users who need to perform daily operations.

1.5 How to Use This Manual

Read this manual carefully before performing operation on the device. Keep the manual in a convenient place for future reference.

All rights reserved including the pictures, symbols, and markings used in this manual. Any reproduction or disclosure, even partially, of the contents of this manual is strictly prohibited without prior written authorization of Sungrow.

The content of the manual will be periodically updated or revised as per the product development. It is probably that there are changes in manuals for the subsequent module edition. If there any inconsistency, the actual product shall prevail.

1.6 Symbol Explanation

This manual contains important safety and operational instructions that must be accurately understood and respected during the installation and maintenance of the equipment.

To ensure the optimum use of this manual, note the following explanations of the symbols used.

DANGER

DANGER indicates a hazard with a high level of risk which, if not avoided, will result in death or serious injury.

WARNING

WARNING indicates a hazard with a medium level of risk which, if not avoided, could result in death or serious injury.

CAUTION

CAUTION indicates a hazard with a low level of risk which, if not avoided, could result in minor or moderate injury.

NOTICE

NOTICE indicates a situation which, if not avoided, could result in equipment or property damage.



NOTE indicates additional information, emphasized contents or tips to help you solve problems or save time.

2 Safety Instruction

This chapter mainly introduces safety instructions that need to be respected during the operation of the COM100.

The COM100 has been designed and tested strictly according to international safety regulations. As electrical and electronic equipment, the COM100 must be installed, commissioned, operated, and maintained in strict accordance with related safety instructions. Incorrect operation or misuse of the device may cause:

- personal injury of the operators or the third party
- device damage of the operators or the third party

Therefore, the following safety instructions must be read and always kept in mind prior to any work. All detailed work-related safety warnings and notes will be specified at the critical points in corresponding chapter.

WARNING

All operation and electrical work must only be performed by qualified personnel.

Before Installation

NOTICE

COM100 complies with FCC/IC RSS-102 radiation exposure limits set forth for an uncontrolled environment.

COM100 should be installed and operated with minimum distance 20cm between the radiator & user's body.

NOTICE

After receiving the device, check if there is damage caused during transport. Contact Sungrow or the forwarding company once any problem is detected.

The related operators must be familiar with the safety instructions in this manual and other safety regulations about the installation, operation and maintenance of the COM100.

Correct moving, transport, installation, operation and maintenance are important for the long-term operation of the Logger1000.

During Installation**NOTICE**

The COM100 can only be used as described in this manual. Alter the product without authorization or use spare parts not sold or recommended by Sungrow may lead to fire, electric shock or other damages.

NOTICE

Disconnect all electrical connections and the upstream input switch to make sure the COM100 is voltage-free during installation.

Maintenance and Replacement **WARNING**

The maintenance of the COM100 can only be performed by qualified personnel from service dept. of Sungrow or other qualified personnel.

User can never maintain or replace the modules and other parts. Serious personal injury or property loss may follow if otherwise.

NOTICE

Never replace the internal components of the COM100 without authorization. Sungrow shall not be held liable for any possible damage caused by ignorance of this warning.

3 Product Introduction

3.1 Function Description

3.1.1 Brief Introduction

With a data logger integrated inside, the COM100 is featured with flexible networking, auxiliary maintenance, and easy operation.

Flexible networking

- Support of RS485, Ethernet, and WiFi communication
- Support of access by various environment sensors, energy meters, and Meteo Stations

Auxiliary maintenance

- Support of batch inverter parameter setting and software upgrading
- Support of remote desktop function, lower maintenance costs
- Support of automatic search and allocation of inverter address, easier onsite debugging
- Support of grid control instruction and power factor control
- Support of local real-time monitoring, unnecessary to connect the Internet

Easy operation

- Equipped with lighting device for ease of night maintenance
- Plastic enclosure, lighter weight and easier installation

3.1.2 Networking Application

The COM100 can monitor running information of the PV system in real time and transfer the information to the background.

As shown in the figure below, the COM100 communicate with iSolarCloud via a switch.

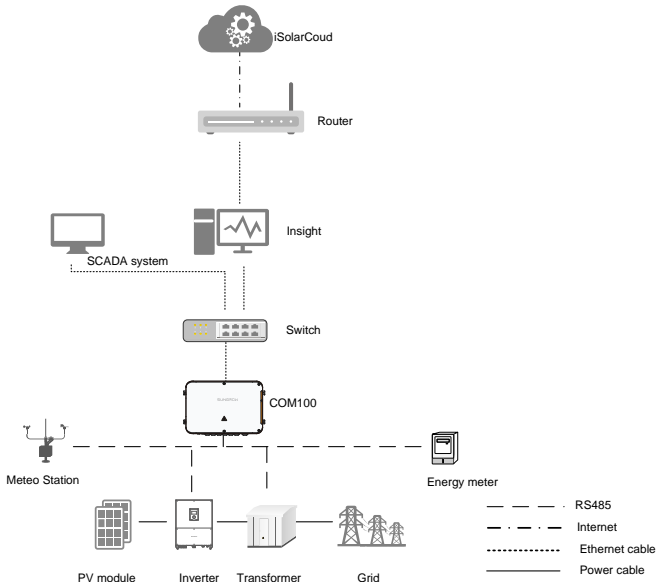

The COM100 can be connected to iSolarCloud via the router or connected to the iSolarCloud via the WiFi or 4G network.

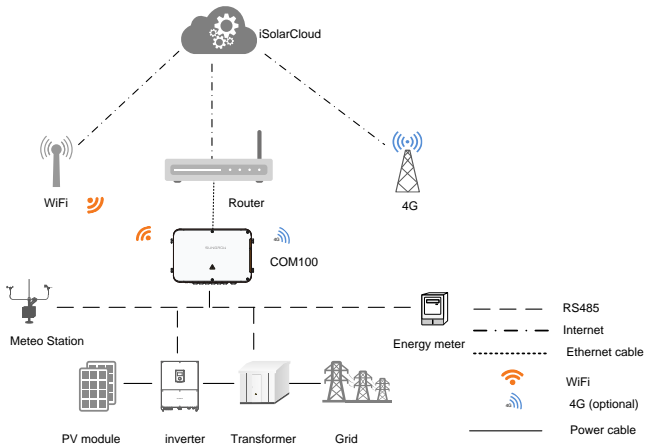

3.2 Appearance

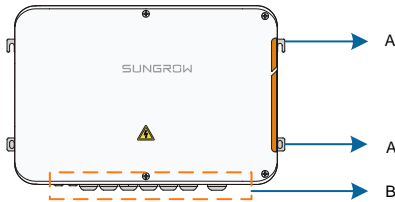

Item	Name	Description
A	Mounting ear	4, for ease of installation
B	Waterproof terminal	-

3.3 Dimensions

The dimensions of the COM100 are as follows:

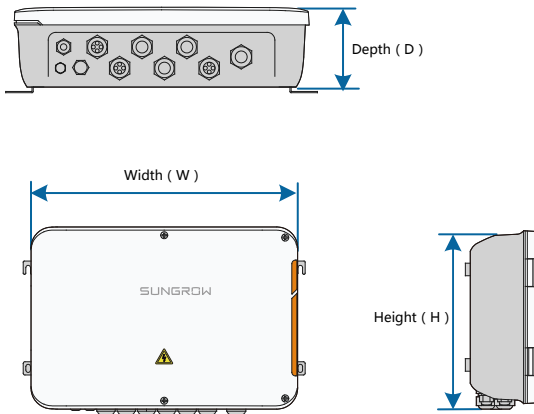

Fig. 3-1 COM100 dimensions

Width (W)	Height (H)	Depth (D)
460mm	315mm	130mm

4 Installation Flow

The following figure shows the overall installation flow of the COM100.

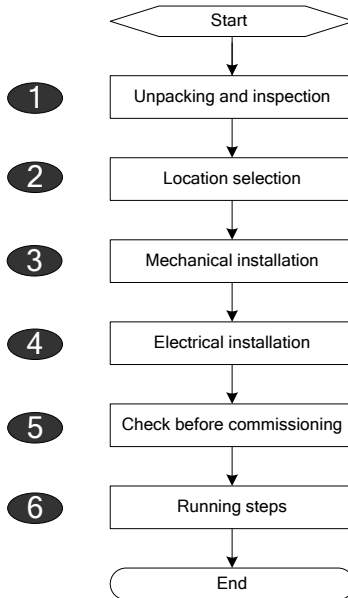

Fig. 4-1 Installation flow

Tab. 4-1 Description of the installation flow

No.	Procedure	Reference chapter
1	Unpacking and inspection	5.1
2	Location selection	5.2
3	Mechanical installation	5.4~5.5
4	Electrical installation	6
5	Check before commissioning	7.1
6	Running steps	7.2

5 Mechanical Installation

5.1 Unpacking and Inspection

Check the scope of delivery for completeness according to the packing list. The following items should be included:

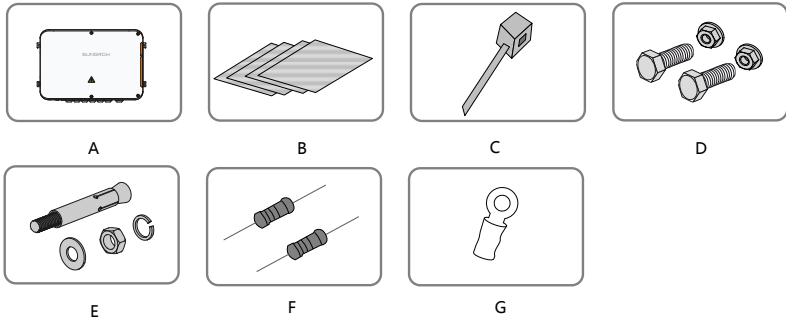

Fig. 5-1 Scope of delivery

Item	Name	Description
A	COM100	-
B	Documents	Quick user manual, delivery inspection report, packing list, warranty card, and certificate
C	Cable tie	12, used for binding the cables
D	Hexagon bolt	4, M6 x 45, used for wall-mounting to fasten the device on the metal surface
E	Expansion bolt	4, M6 x 60, used for wall-mounting to fasten the device on the concrete wall
F	Terminal resistor	6x120Ω Note: if there are more than 15 devices connected on the RS485 bus, it is recommended to connect a 120Ω terminal resistor in parallel on the A and B lines at the head (or tail end) of the bus
G	OT terminal	M5x10, used for grounding connection









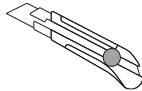

5.2 Location Requirements

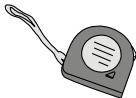

Environment Requirements

- With the ingress of protection IP66, the COM100 can be installed both indoors and outdoors (more often).
- Ambient temperature: -30°C to +60°C; and ambient humidity: ≤ 95%. If otherwise, the internal components will be damaged.
- Take anti-moisture and anti-corrosion measures.

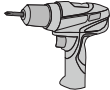
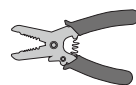
5.3 Installation Tools

Installation tools include but are not limited to the following recommended ones. If necessary, use other auxiliary tools on site.

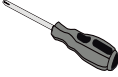
Type	Tool			
	Utility knife	Marker	Measuring tape	Protective gloves
				
General tools	Dust mask	Goggles	Vacuum cleaner	-
				
Installation tools	Hammer drill	Electric screwdriver	Wire stripper	Wire clipper
				

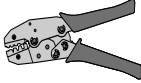
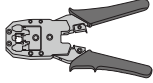
Type	Tool			
	Phillips screwdriver	Rubber mallet	Crimping tool	RJ45 crimping tool
				

5.4 Installation Method

The COM100 can be installed in wall-mounting manner or pole-mounting manner.

⚠ WARNING

Be aware of the weight of the COM100 throughout the installation process!

Tip over or fall of the device due to inappropriate operation can cause personal injury!

5.4.1 Wall-Mounting



Mount the COM100 onto the concrete wall or metal surface according to onsite conditions.

⚠ DANGER

Avoid drilling holes in the utility pipes and/or cables attached to back of the wall!

NOTICE

Operation personnel should wear goggles and dust mask throughout the drilling process to avoid dust inhalation or contact with eyes..

The following figure shows the installation dimensions of the COM100.

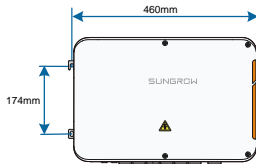

Concrete Wall

Step 1 Select an appropriate installation surface.

Step 2 Mark positions for drilling holes with a marker.

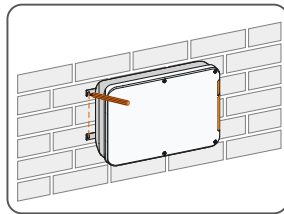

Step 3 Drill the holes with a drill according to the marks made before.

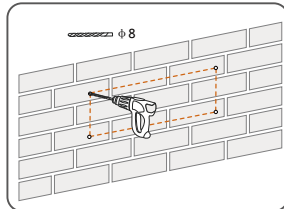

Step 4 Secure all the expansion bolts into the holes with a rubber hammer.

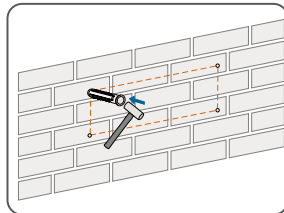

Step 5 Fix the COM100 onto the installation surface with the enclosed fasteners.

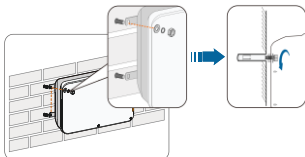

Metal Surface

Step 1 Select an appropriate installation surface.

Step 2 Mark positions for drilling holes with a marker.

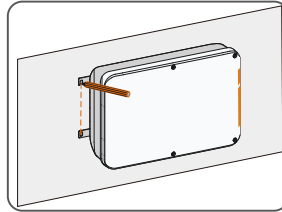

Step 3 Drill the holes with a drill according to the marks made before.

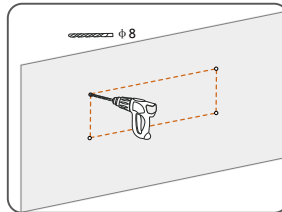

Step 4 Fix the COM100 onto the installation surface with the enclosed fasteners.

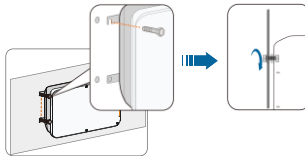

Step 5 Check and ensure that the COM100 is firmly in place.

5.4.2 Pole-Mounting (Optional)

The COM100 can be installed in the pole-mounting manner which should be specified when you place an order. Sungrow will design according to actual installation conditions.

Accessories supplied with the COM100 include matching screw assembly, nuts, brackets, clamps, etc.

The installation procedure is as follows:

Step 1 Anchor the COM100 to the mounting-brackets by using the screw assembly via the mounting ears, as shown in the figure below.

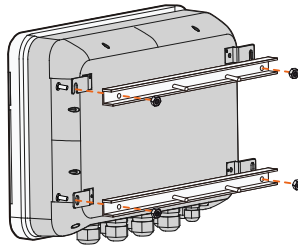

Step 2 Fix the mounting-brackets with the clamps by using the nuts.

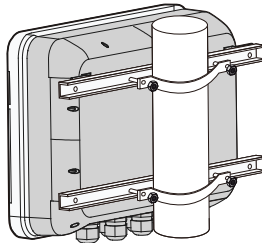

5.5 Antenna Connection (Optional)

The COM100 comes standard with a antenna. If the COM100 is to be installed in a container, purchase a sucker antenna.

Step 1 Release the 4 screws on the front side of the COM100 and open the front cover of the cabinet.

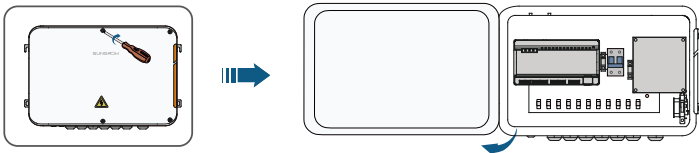

Step 2 Loosen the "RF" waterproof terminal on the bottom of the COM100.

Step 3 Lead the antenna through the "RF" waterproof terminal, and secure clockwise the nut at the end of the antenna to the corresponding terminal on the bottom of the Logger1000.

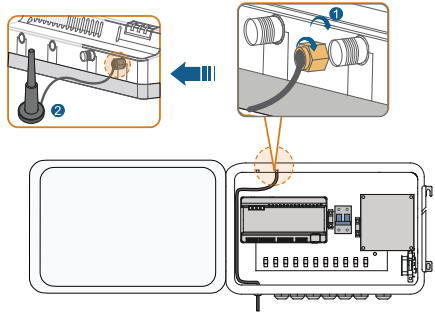

Step 4 Place the sucker antenna base on a metal surface outside the container.

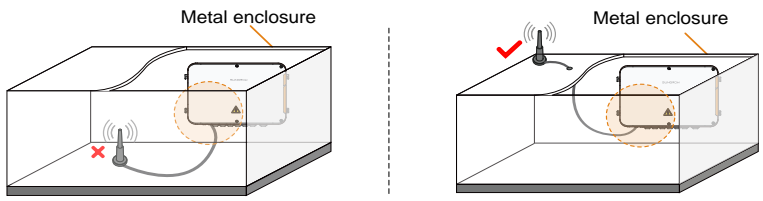

6 Electrical Connection

6.1 Waterproof Terminal Description

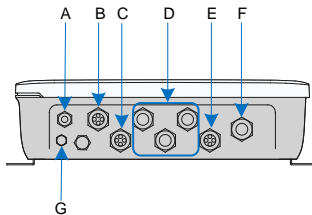

Fig. 6-1 Waterproof terminals on the bottom of COM100

Tab. 6-1 Description of waterproof terminals

Item	Label	Description
A	RF	Reserved, antenna waterproof terminal
B	AI/DI	AI/DI waterproof terminal
C	DI/DRM	DI/DRM waterproof terminal
D	RS485-1, RS485-2, RS485-3	RS485 waterproof terminal
E	ETH	Ethernet waterproof terminal
F	AC (100~277V)	Waterproof terminal for 100Vac~277Vac power supply
G	-	Waterproof and dustproof ventilation valve

6.2 Internal Structure

The internal structure of the COM100 is shown in the following figure.

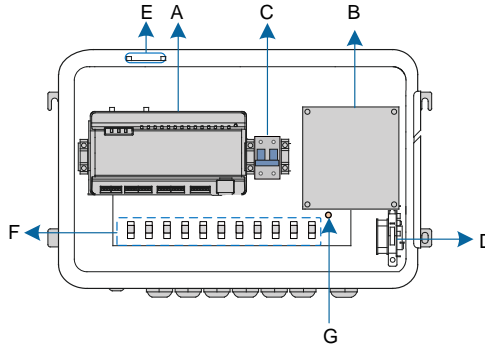

Item	Description
A	Logger1000A or Logger1000B
B	Switch-mode power supply and surge protection device, 24Vdc power supply
C	Micro circuit breaker, used to connect/disconnect the external 220Vac power supply
D	Lighting device, turn on the light before opening the front cover of the cabinet for ease of night maintenance
E	Antenna
F	Cable tie buckle, used for binding cables
G	Grounding terminal

6.3 Preparation Before Cable Connection

Step 1 Release the 4 screws on the front side of the COM100 and open the front cover of the cabinet, as shown in the figure below.

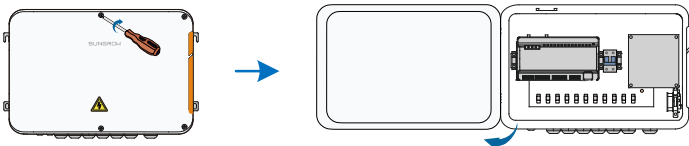

Step 2 Turn the internal power switch of the COM100 to the "OFF" position to ensure the COM100 is voltage-free.

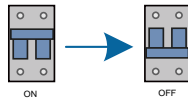

6.4 Grounding

Step 1 Strip the insulation cover of the grounding cable and crimp the stripped cable to the OT terminal.

Step 2 Fasten the grounding cable in the sequence of cross recessed fastener assembly, OT terminal, and grounding hole.

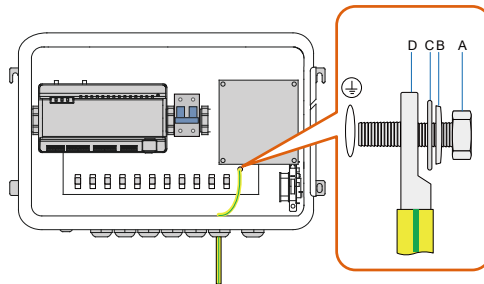

Item	Description
A	M5x10 cross recessed fastener assembly
B	Flat washer
C	Spring washer
D	OT terminal

6.5 RS485 Port

6.5.1 Connect to the Device with RS485 Port

RS485 communication terminals inside the COM100 are located at the bottom of the Logger, including A1B1, A2B2, and A3B3.

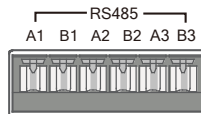

Communication cable specification:

Cable	Type
RS485 cable	Outdoor ultraviolet protection shielded twisted pair (STP)

Step 1 Loosen the "RS485-1/2/3" waterproof terminal on the bottom of the COM100.

Step 2 Lead the RS485 cable through the "RS485-1/2/3" waterproof terminal. Strip the cable jacket and insulation layer of the communication cable with a wire stripper respectively.

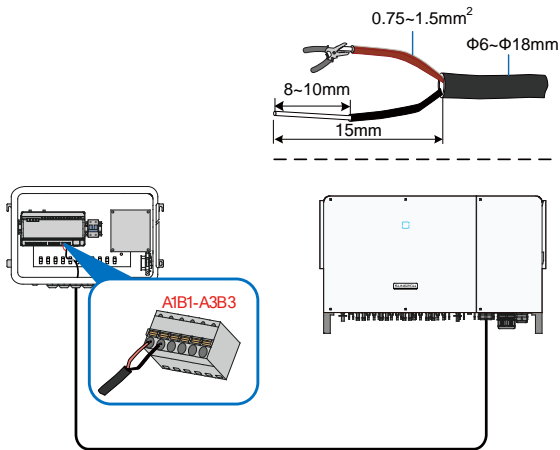

NOTICE
RS485A is connected to port A while RS485B is connected to port B.

Step 3 Connect the stripped cable to the RS485 ports of the Logger1000, as shown in the figure below.

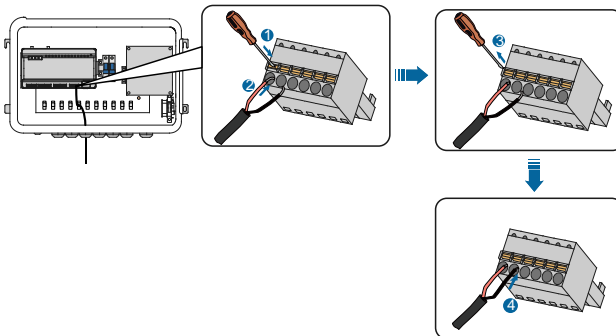

Step 4 Fasten the "RS485-1/2/3" waterproof terminal.

6.5.2 Connect to the Device with RJ45 Port

Communication cable specification:

Cable	Type
ETH communication cable	Outdoor STP Ethernet cable

Step 1 Loosen the "RS485-1/2/3" waterproof terminal on the bottom of the COM100.

Step 2 Lead the Ethernet cable through the "RS485-1/2/3" waterproof terminal. Strip the insulation layer of the communication cable with an Ethernet wire stripper.

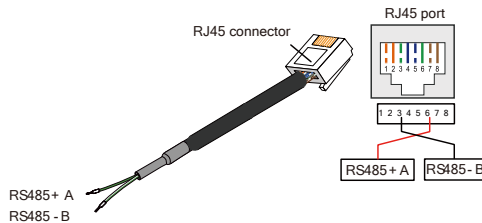

Tab. 6-2 Correspondence between wire colour and pin of RJ45 connector

Pin	Color	Pin	Color
1	White-and-orange	5	White-and-blue
2	Orange	6	Green
3	White-and-green	7	White-and-brown
4	Blue	8	Brown

Step 3 Insert the stripped communication cable into the RJ45 connector in the correct order, and crimp it with a crimping tool.

Step 4 Insert the RJ45 connector of the Ethernet communication cable into the "ETH" port of the Logger1000.

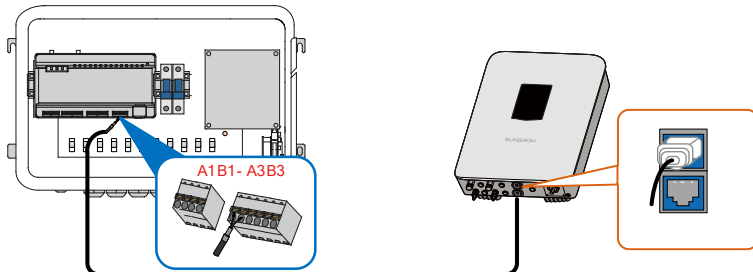

Step 5 Fasten the "RS485-1/2/3" waterproof terminal.

6.6 Ethernet Port

The COM100 can be connected to the background of the PV system via the Ethernet port, and the communication protocol is standard Modbus TCP or IEC104.

Step 1 Prepare a suitable length of Ethernet cable.

Step 2 Insert one end of the cable into the port of the Ethernet switch and the other end to the "ETH" port of the Logger1000 inside the COM100.

Step 3 Set IP address of the ETH port to be within the same network segment as that of the background monitoring system.

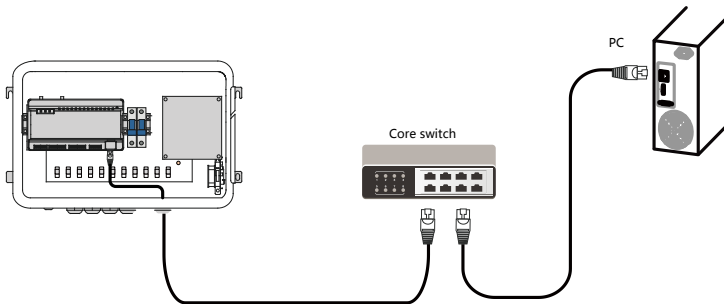

Fig. 6-2 Connection to PV background system

NOTICE

Default IP of the "ETH": IP12.12.12.12.

6.7 External AC Power Supply Cable

External AC power supply ports are provided on the bottom of external power supply circuit breaker inside the COM100, as shown in the figure below.



Power cable specification:

Cable	Type
Power cable	Outdoor ultraviolet protection cable

Step 1 Loosen the "AC (100~277V)" waterproof terminal, and insert the external

power supply cable through the waterproof terminal into the corresponding terminal of the micro circuit breaker inside the COM100.

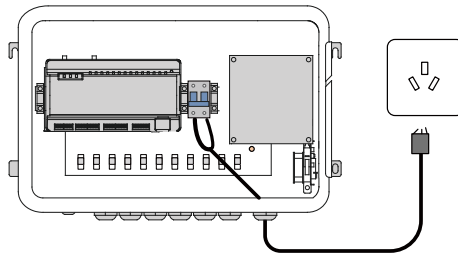

Step 2 Strip and connect the cable to the corresponding terminal inside the COM100.

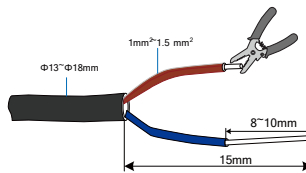

Step 3 Fasten the "AC (100~277V)" waterproof terminal.

6.8 External DC Power Supply Cable

The 24Vdc power supply port inside the COM100 is the "24V IN" and "24V OUT" port on the bottom of the Logger. The rated power is 10W and the max. power is 12W.

The COM100 can supply the connected external device with 24Vdc power.

DC cable specification:

Cable	Type
DC cable	Outdoor ultraviolet protection STP

Step 1 Loosen an unused waterproof terminal on the bottom of the COM100.

Step 2 Lead the DC cable through the waterproof terminal. Strip the cable jacket and insulation layer of the DC cable by appropriate length with a wire stripper.

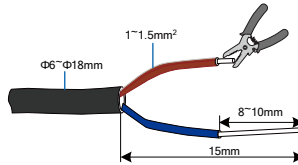

Step 3 Insert the stripped DC cable into the port "24V IN" and "24V OUT" of the Logger1000.

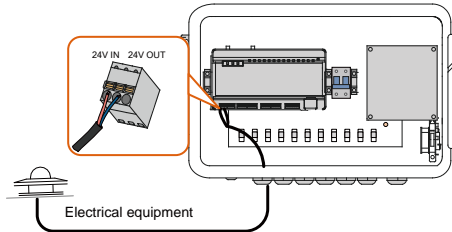

Step 4 Fasten the waterproof terminal.

6.9 Inspection after Cable Connection

Conduct the following operations after finishing electrical cable connection:

- Check that all cables are correctly connected.
- Gently pull the cables backwards to ensure they are firmly in place.
- Fasten all the waterproof terminals and seal gaps at the bottom of the terminals with fireproofing mud.
- Close the front cover of the COM100 and tighten the screws.

7 Commissioning

7.1 Check before Commissioning

No.	Item	Result
1	All cables are intact, well insulated, and appropriately dimensioned	<input type="checkbox"/>
2	All cables are connected correctly and firmly	<input type="checkbox"/>
3	The polarity of the power supply cable is correct. The ground cable is reliably grounded	<input type="checkbox"/>
4	Seal the gaps at the bottom of the waterproof terminals with fireproof mud	<input type="checkbox"/>

7.2 Commissioning Steps

When all the foregoing items meet requirements, commission the COM100 for the first time.

No.	Step	Result
1	Inspection before commissioning	<input type="checkbox"/>
2	Turn the micro-circuit breaker inside the COM100 to the ON position.	<input type="checkbox"/>
3	Check whether the indicators of Logger1000 inside the COM100 normally flash.	<input type="checkbox"/>
4	Connect the debugging PC to the "ETH" port of the Logger1000 via the network cable (default IP address of "ETH": 12.12.12.12). Log in the Web at 12.12.12.12 through the IE or Chrome browser.	<input type="checkbox"/>
5	Make sure the communication cable connecting the device and the Logger1000 inside the COM100 is firmly in place, and connect the DC circuit breaker of the inverter to ensure the inverter is supplied with power.	<input type="checkbox"/>
6	Configure related parameters referring to the user manual of Logger1000.	<input type="checkbox"/>
7	Enable the DHCP service of the router.	<input type="checkbox"/>
8	Set the iSolarCloud address if data needs to be uploaded to cloud server.	<input type="checkbox"/>

No.	Step	Result
	<p>The default iSolarCloud station is "China Station".</p> <ul style="list-style-type: none"> • Users in mainland China access the "China Station". • Users in Europe access the "Europe Station". • Users in other regions access the "International station". 	
9	Check the data of SUNGROW string inverter for correctness on the real-time information interface.	<input type="checkbox"/>
10	Create new plant via the iSolarCloud APP and check the iSolarCloud data for correctness.	<input type="checkbox"/>

The auto search function is available for SUNGROW residential inverters and string inverters only whose addresses are automatically allocated.



Devices of other types, such as energy meter and transformer, can be connected to Logger1000 with the adding device function.

Addresses of the device connected to the same communication port should be different from each other.

Save the settings after operation, and otherwise the settings will not take effect.

Use the iSolarCloud APP to create a new plant. Users can directly scan the QR code on the front label of the Logger1000 or manually input the S/N to add communication equipment. For details, refer to the Quick Guidance of iSolarCloud APP. Scan the bottom QR Code to view or obtain the Quick Guidance of iSolarCloud APP.



8 Grid Dispatching Function



Only installation personnel with some communication knowledge can perform operations described in this chapter.

8.1 Function Description

The COM100 not only serves as a communication management device of a single PV array/plant, but also has the power regulation function. Multiple regulation manners can meet different regulation requirements. The Logger1000 can regulate the power output of the SUNGROW inverter, and the regulation mainly includes active power control and reactive power regulation.

The COM100 can control device power output according to the local preset instructions. In addition, it can receive regulation instructions via the remote communication (IEC104, MODBUS, and TCP), AI, and dry contact (DI).

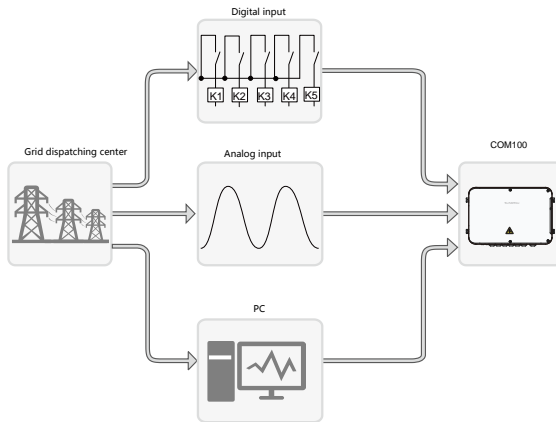

Fig. 8-1 Overall frame of power control function

The COM100 supports closed-loop power regulation. The regulation accuracy and real-time performance can be further improved by adding an energy meter.

The COM100 supports fast instruction transfer channels (ms-level processing delay) while ensuring that the dispatching instructions are correctly transmitted to all inverters.

NOTICE

The corresponding power dispatching function is available only when the inverter supports active power control, power factor control, and reactive power regulation!

For details, refer to the inverter user manual or consult the local retailers.

8.2 Interface Description

The COM100 is equipped with digital control ports and analog control ports for receiving digital instructions and analog instructions sent from the grid dispatching center.

8.2.1 Digital Control Interface

Digital control interface is located at the bottom of the Logger1000 inside the COM100.

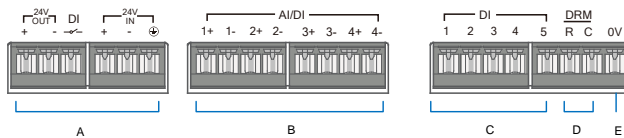

Tab. 8-1 Digital control interface signal definition

Item	Signal	Definition
A	DI	Switch for enabling the AI/DI function
B	AI/DI (1+, 1-, 2+, 2-, 3+, 3-, 4+, 4-)	4 analog input channels, and can be switched to 4 dry contact signal channels.
C	DI (1, 2, 3, 4, 5)	5 independent input dry contact signal channel
D	DRM (R, C)	Works together with the DI1 to DI4 to achieve the DRM function
E	0V	Input dry contact signal ground

Wireless receiver controller (Ripple Control Receiver)

Wiring between the COM100 and the Ripple Control Receiver is as follows:

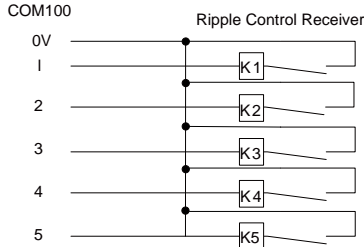

In Germany and some other European countries, the grid company uses the Ripple Control Receiver to convert the grid dispatching signal and send it in a dry contact manner. In this case, the plant needs to receive the grid dispatching signal in the dry contact communication manner.

Reactive power dry contact

Wiring of the reactive power dry contact is shown in the figure below:

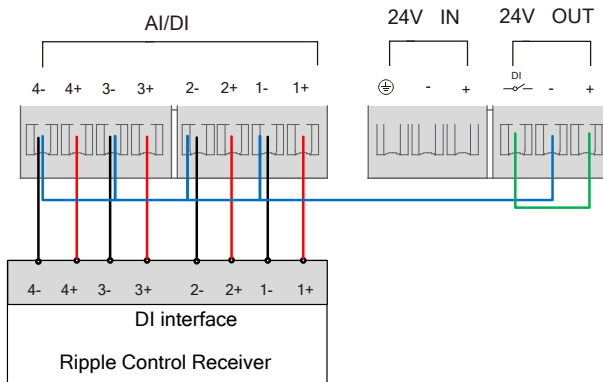

Fig. 8-2 Wiring of the reactive power dry contact

AI/DI function

On the bottom of the Logger1000, there are 4 groups of ports (1+, 1-, 1+, 1-, 2+, 2-, 3+, 3-, 4+, 4-) compatible with the AI/DI function.

When enabling the AI/DI function, use a power cable to connect the "24V OUT+" port and the DI port, shown by the green line in the "fig. 8-2 Wiring of the reactive power dry contact".

Active power dry contact

Wiring of the active power dry contact is shown in the figure below:

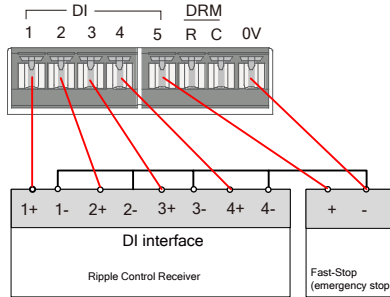
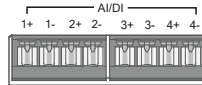

Fig. 8-3 Wiring of the active power dry contact

8.2.2 Analog Control Interface

The analog control interface is at the bottom of the COM100, and a sum of 4 analog input ports are provided, as shown in the figure below.



Tab. 8-2 Analog control interface signal definition

Signal	Definition
1+, 1-, 2+, 2-, 3+, 3-, 4+, 4-	4 analog input channels

The COM100 supports 4 inputs of 4~20mA analog currents or 4 inputs of 0~10V analog voltage.

8.2.3 DRM Control Interface

The Demand Respond Modes (Demand Respond Modes, DRM for short) control interface is located at the bottom of the Logger1000 inside the COM100, as shown in the figure below.

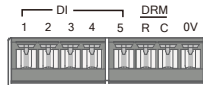

The DRM interface works together with DI1~DI4 to achieve the DRM function.

Wiring between the COM100 and the DRED is as follows:

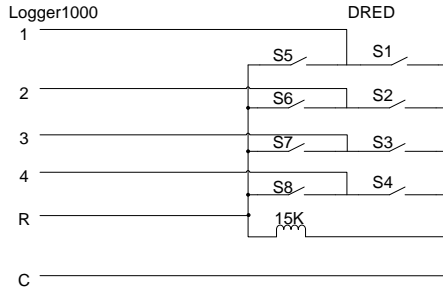

The DRM interface requires that the COM100 can be connected to the DRED via the corresponding wiring terminal or RJ45 connector.

9 WEB Interface

9.1 Running Requirements

Item	Parameter
System	WIN7, WIN8, WIN10, or Mac OS
Browser	IE10 or later, Chrome45 or later, Safari11 or later
Min. resolution	1366 x 768
CPU	CPU frequency higher than 2.5GHz

9.2 Configure PC Network Parameters

The COM100 and the PC can communication via the Ethernet or the WiFi. Corresponding configuration of network parameters is as follows:

Communication manner	Configuration	WEB address
(ETH) Ethernet	Set the IP address of the PC and COM100 to the same network segment. The IP address of the COM100 is 12.12.12.12. Therefore, the IP address of the PC may set to 12.12.12.125, and the subnet mask is 255.255.255.0.	12.12.12.12
WiFi	Turn on the wireless network setting of the PC. Search for the wireless network name of the internal Logger1000 and connect to it.	11.11.11.1

Note: Access the WEB page in either of the manners according to actual conditions.

9.3 Login Steps

In this chapter, login steps are briefly described by using the WiFi login as an example.

Step 1 Turn on the wireless network setting of the PC, and search for the wireless network name of the Logger1000, for example, "SG-A1234567890".



The format of the wireless network name is SG-X. "X" represents the serial number of the Logger1000 and can be obtained from the outer surface of the Logger1000.
The wireless network can be connected without the need of password.

Step 2 Enter the IP address 11.11.11.1 of the COM100 in the PC address bar to enter the general user login interface.

Step 3 Click the button "Login" in the upper right corner, enter the default password "pw1111", and click "Login", to enter the O&M user interface.

User type	Operation permission
General user	The general user can view basic information, real-time fault, and device monitoring information of the COM100.
O&M user	In addition to the permissions of the general user, the O&M user can set and modify parameters of the COM100 and devices connected to the COM100.



After login for the first time, it is recommended to change the password. Click "O&M user" -> "Modify password" to change the password. In case the password is forgotten, contact SUNGROW to obtain a new one, with system time and Logger1000 S/N provided.

9.4 Interface Introduction

Users may perform the following operations after entering the WEB interface.

Operation	Path	Manual and website
Create new plant	1. Click "About" on the WEB interface to obtain the QR code. 2. Scan the QR code with the iSolarCloud App and create new plants according to the prompt information.	Quick guidance of the iSolarCloud APP http://support.sungrowpower.com/web/productDataDetail?id=353
Logger configuration	-	http://support.sungrowpower.com/web/productList?f=3&directoryId=307

10 Appendix

10.1 Technical Parameters

Communication	
No. of supportable device	30 at most
RS485 interface	3
Ethernet port	1, 10/100/1000Mbps self-adaptive
Digital input port	5
Analog input port	4, support of 4 ~ 20mA or 0 ~ 10Vdc
Wireless communication	
Operator	Support of China Mobile/China Unicom/China Telecom, 4G/3G/2G
4G band	frequency LTE(FDD): B1, B3, B5, B8 LTE(TDD): B38, B39, B40, B41 TD-SCDMA: B34, B39 CDMA: BC0 GSM: 900 MHz /1800 MHz WCDMA: B1,B8
WiFi communication	802.11 b/g/n/ac; HT20/40/80MHz; 2.4GHz/5GHz
Power supply	
AC input	100 Vac ~ 277 Vac, 50/60 Hz
Power consumption	Avg. 20W; Max. 30W
Lighting device	<1 W
Ambient parameter	
Operating temperature	-30°C ~ +60°C
Storage temperature	-40°C ~ +85°C
Operating humidity	≤95% (no condensation)
Operating altitude	≤4000m
Ingress protection	of IP66
Mechanical parameters	
Dimensions (W x H x D)	460 mm x 315 mm x 130 mm
Weight	6 kg
Installation	Bracket-mounting, wall-mounting, or pole-mounting

manner	(optional)
Enclosure material	Plastic (PC)

10.2 Quality Guarantee

SUNGROW shall service or replace the faulty product for free within the warranty period.

Evidence

Within the warranty period, SUNGROW shall require the customer to present the purchase invoice and date. The trademark on the product shall be clearly visible, and SUNGROW shall hold no liability if otherwise.

Conditions

- The replaced failure product needs to be disposed of by SUNGROW.
- The client needs to reserve enough troubleshooting time for SUNGROW.

Exclusion of Liability

The following cases shall void the warranty claims of SUNGROW.

- The free warranty periods for the whole machine/components have expired
- The device is damaged during transport
- The device is installed, altered, or operated incorrectly
- The device operates in an environment harsher than that described in this manual
- The fault or damage is caused due to installation, maintenance, alteration, or disassembly performed by persons not from SUNGROW
- The fault or damage caused by using non-standard components or software or using components or software not from SUNGROW
- The installation and use do not comply with stipulations of relevant international standards
- The damage is caused by unpredictable factors

For the foregoing faults or damages, SUNGROW can provide a paid service at the request of the client after judgment.



The dimensions and parameters of the device are subject to changes without notification, and reference can be made to the latest document.

Software licenses

- It is prohibited to use data contained in firmware or software developed by SUNGROW, in part or in full, for commercial purposes by any means.
- It is prohibited to perform reverse engineering, cracking, or any other operations that compromise the original program design of the software developed by SUNGROW.

10.3 Contact

Should you have any question about this product, please contact us.

We need the following information to provide you the best assistance:

- Type of the device
- Serial number of the device
- Fault code/name
- Brief description of the problem

<p>China (HQ)</p> <p>Sungrow Power Supply Co., Ltd</p> <p>Hefei</p> <p>+86 551 65327834</p> <p>service@sungrowpower.com</p>	<p>Australia</p> <p>Sungrow Australia Group Pty. Ltd.</p> <p>Sydney</p> <p>+61 2 9922 1522</p> <p>service@sungrowpower.com.au</p>
<p>Brazil</p> <p>Sungrow Do Brasil</p> <p>Sao Paulo</p> <p>+55 11 2366 1957</p> <p>latam.service@sa.sungrowpower.com</p>	<p>France</p> <p>Sungrow France – Siege Social</p> <p>Paris</p> <p>service.france@sungrow.co</p>
<p>Germany</p> <p>Sungrow Deutschland GmbH</p>	<p>Greece</p> <p>Service Partner – Survey Digital</p>

München	+30 2106044212
+49 89 324 914 761	service.greece@sungrow.co
service.germany@sungrow.co	
India	Italy
Sungrow (India) Private Limited	Sungrow Italy
Gurgaon	Milano
+91 080 41201350	service.italy@sungrow.co
service@in.sungrowpower.com	
Japan	Korea
Sungrow Japan K.K.	Sungrow Power Korea Limited
Tokyo	Seoul
+ 81 3 6262 9917	+82 70 7719 1889
japanservice@jp.sungrowpower.com	service@kr.sungrowpower.com
Malaysia	Philippines
Sungrow SEA	Sungrow Power Supply Co., Ltd
Selangor Darul Ehsan	Mandaluyong City
+60 19 897 3360	+63 9173022769
service@my.sungrowpower.com	service@ph.sungrowpower.com
Thailand	Spain
Sungrow Thailand Co., Ltd.	Sungrow Ibérica S.L.U.
Bangkok	Navarra
+66 891246053	service.spain@sungrow.co
service@th.sungrowpower.com	
Romania	Turkey
Service Partner - Elerex	Sungrow Deutschland GmbH
+40 241762250	Turkey Istanbul Representative Bureau
service.romania@sungrow.co	Istanbul
	+90 212 731 8883

service.turkey@sungrow.co

UK

Sungrow Power UK Ltd.
Milton Keynes
+44 (0) 0908 414127
service.uk@sungrow.co

U.S.A, Mexico

Sungrow USA Corporation
Phoenix Arizona
+1 833 747 6937
techsupport@sungrow-na.com

Vietnam

Sungrow Vietnam
Hanoi
+84 918 402 140
service@vn.sungrowpower.com
